

Pendant lamp

TRIANGLE

Pendant lamp in anodized or powder coated aluminium.
Lampada a sospensione in alluminio anodizzato o verniciato.



Down light

31W LED
3286 lm
3000K
CRI90
ON-OFF | All in one

Up/Down light

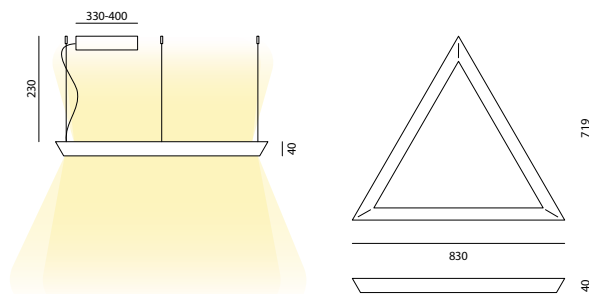
49W LED
5194 lm
3000K
CRI90
ON-OFF | All in one



CE IP20   24V  MacAdam Step 3 UGR₁₉

LAMP FINISH OPTIONS FINITURE LAMPADA



Anodized aluminium





Matt White



Pendant lamp in anodized aluminium.
Lampada a sospensione in alluminio anodizzato.

11,6W LED
3000K
CRI80

CE IP20  LED 24V 1230lm  MacAdam Step 3 UGR₁₉

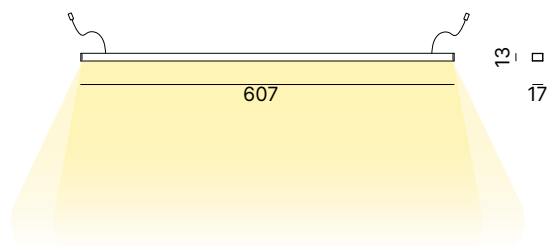

DESIGN LIGHTING

LAMP FINISH OPTIONS
FINITURE LAMPADA



Anodized aluminium



Pendant or wall-mounted sound-absorbing triangular panel, fabric upholstered.
Pannello fonoassorbente triangolare, a parete o sospensione, rivestito in tessuto.

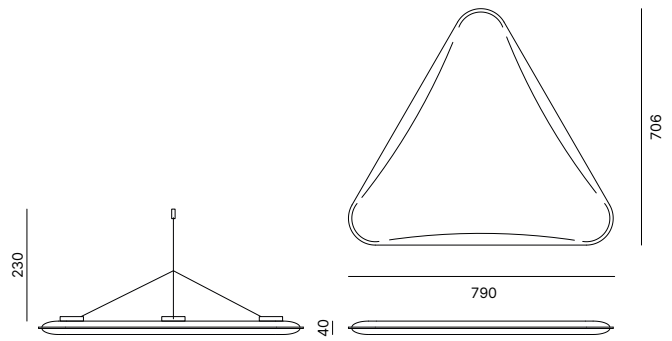

DESIGN LIGHTING

PANELS FINISH OPTIONS
FINITURE PANNELLI

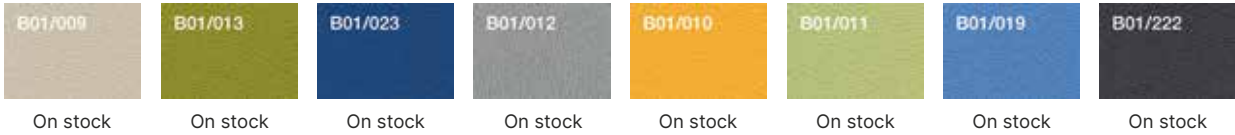

DETAILS
DETTAGLI



Linking

Pendant or wall-mounted sound-absorbing 120° panel, fabric upholstered.
Pannello fonoassorbente 120°, a parete o sospensione, rivestito in tessuto.

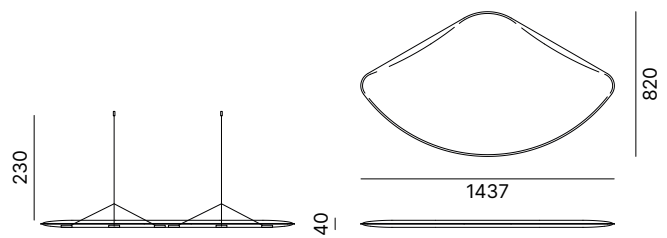

DESIGN LIGHTING

PANELS FINISH OPTIONS
FINITURE PANNELLI



DETAILS
DETTAGLI



Linking

Pendant sound-absorbing triangular panel, fabric upholstered.

Pannelli triangolari fonoassorbenti rivestiti in tessuto, a sospensione verticale.

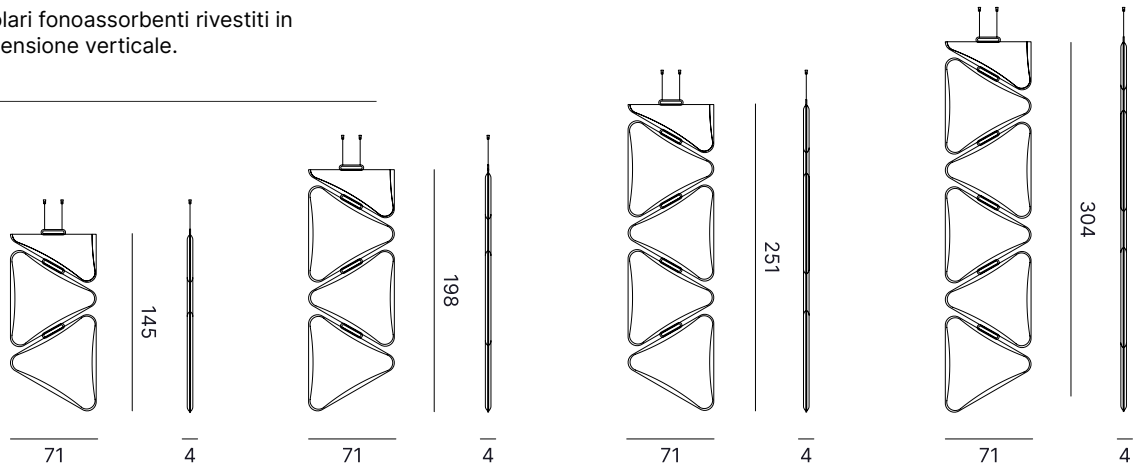

DESIGN LIGHTING

PANELS FINISH OPTIONS
FINITURE PANNELLI

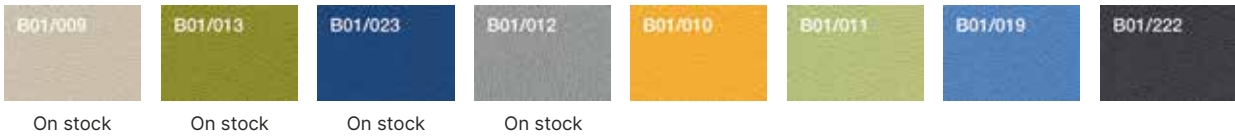

STRUCTURE FINISH OPTIONS
FINITURE STRUTTURA



Acoustic panel

PETAL FLOOR STAND

Powder coated metal frame. 3 fabric upholstered sound-absorbing panels.

Piantana in metallo verniciato. 3 pannelli fonoassorbenti 120° rivestiti in tessuto.

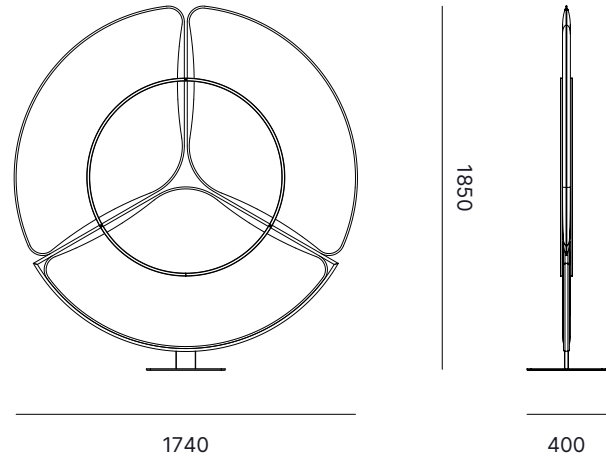

DESIGN LIGHTING

PANELS FINISH OPTIONS FINITURE PANNELLI

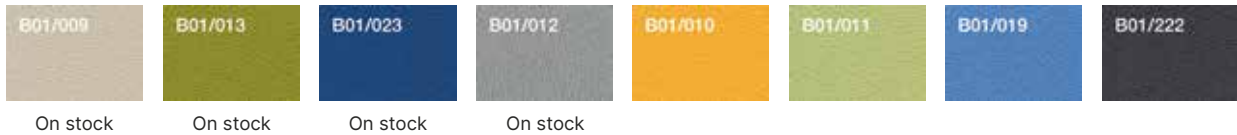

FRAME FINISH OPTIONS FINITURE PIANTANA

